

1 Electrical Characteristics

1.1 Technical Data

	Symbol	Value	Unit
Maximum allowable continuous AC voltage*1	V_{RMS}	7.0	V
Maximum allowable continuous DC voltage	V_{DC}	9.0	V
Varistor voltage Measured*2	V_B	12	V
Typical capacitance value measured*3	C	<100	pF
Typical capacitance value tolerance		± 30	%
Maximum clamping voltage measured*4	V_C	23	V
Rated peak single pulse transient current at *5	I_P	20	A

1.2 Reference Da

Maximum Energy Absorption 10/1000 μ s	E	0.05	J
Response time	T_{rise}	<2	ns
Leakage current at V_{DC} (At initial state)	I_L	<50	μ A
Leakage current at V_{DC} (After reliability Test)	I_{LA}	<100	μ A
Operating ambient temperature		-40~+85	$^{\circ}$ C
Storage temperature		-40~+125	$^{\circ}$ C
Reflow temperature profile(Recommend)		260	$^{\circ}$ C

1.3 Other Data

Body	ZnO
End termination	Ag/Ni/Sn
Packaging	Bulk/Tape
Complies with Standard	IEC61000-4-5

Notes:

*1 AC voltage at 50~60Hz

*2 Varistor voltage

Measured at 1mA DC

*3 Capacitance

Measured at $f=1\text{MHz}$, $V_{rms}=0.5\text{V}$

*4 Maximum clamping voltage

Measured at 1A by 8/20 μ s Pulse

*5 Rated peak single pulse transient current

Measured by 8/20 μ s Pulse

Size:

Unit: mm

Type	Length (L)	Width (W)	High (H)	Termination (L1)
0402	1.00 ± 0.15	0.50 ± 0.15	0.70(max)	0.25 ± 0.10

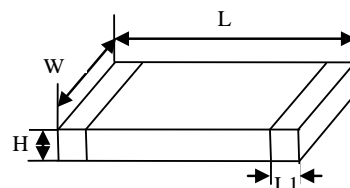

2.Size

Model	1005(0402)	1608(0603)	2012(0805)	3216(1206)	3225(1210)	4532(1812)	5750(2220)	8050(3220)
Length(L)	1.00±0.15	1.60±0.20	2.00±0.20	3.20±0.20	3.20±0.20	4.50±0.30	5.70±0.30	8.0±0.30
Width(W)	0.50±0.15	0.80±0.20	1.20±0.20	1.60±0.20	2.50±0.20	3.20±0.20	5.00±0.30	5.00±0.30
High(H)	0.70max	0.90max	1.30max	1.60max	2.50max	3.20max	4.50max	4.50max

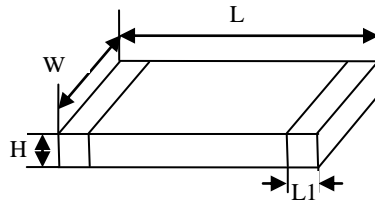

3.Surge Wave Form

Wave shape "Short circuit" (Current I_{sc})

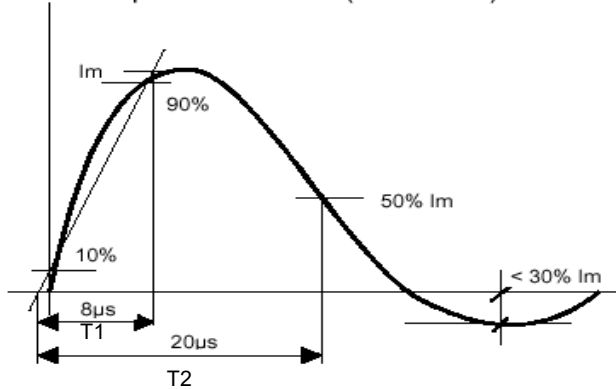

SEVERITY LEVEL	T1	T2
1	8 μs	20 μs
2	10 μs	1000 μs

8/20 μs waveform current

IEC61000-4-5 Standards

4.Environmental Reliability Test

Characteristic	Test method and description			
High Temperature Storage	The specimen shall be subjected to 125°C for 1000 hours in a thermostatic bath without load and then stored at room temperature and humidity for 1 to 2 hours. The change of varistor voltage shall be within 10%.			
Temperature Cycle	The temperature cycle of specified temperature shall be repeated five times and then stored at room temperature and humidity for one two hours. The change of varistor voltage shall be within 10% and mechanical damage shall be examined.	Step	Temperature	Period
		1	-40±3°C	30min±3
		2	Room Temperature	1~2hours
		3	125±2°C	30min±3
4	Room Temperature	1~2hours		
High Temperature Load	After being continuously applied the maximum allowable voltage at 85°C for 1000hours, the specimen shall be stored at room temperature and humidity for one or hours, the change of varistor voltage shall be within 10%.			
Damp Heat Load/ Humidity Load	The specimen should be subjected to 40°C, 90 to 95%RH environment, and the maximum allowable voltage applied for 1000 hours, then stored at room temperature and humidity for one or two hours. The change of varistor voltage shall be within 10%.			
Low Temperature Storage	The specimen should be subjected to -40°C, without load for 1000 hours and then stored at room temperature for one two hours. The change of varistor voltage shall be within 10%.			

5.Soldering Recommendation

The principal techniques used for the soldering of components in surface mount technology are infrared reflow and wave soldering.

7.1 Pb free solder paste

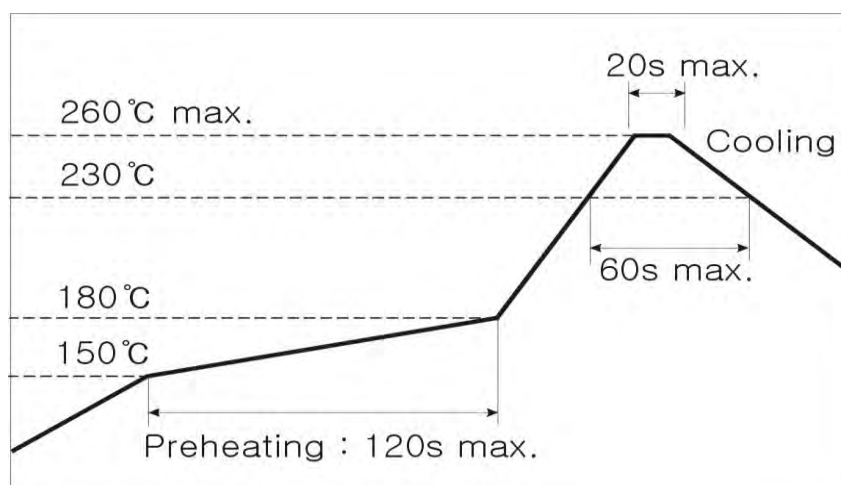

7.2 Repair soldering

7.2.1 Allowable time and temperature for making correction with a soldering iron: 350 ± 10 °C, 3 sec.

7.2.2 Optimum solder amount when corrections are made using a soldering iron

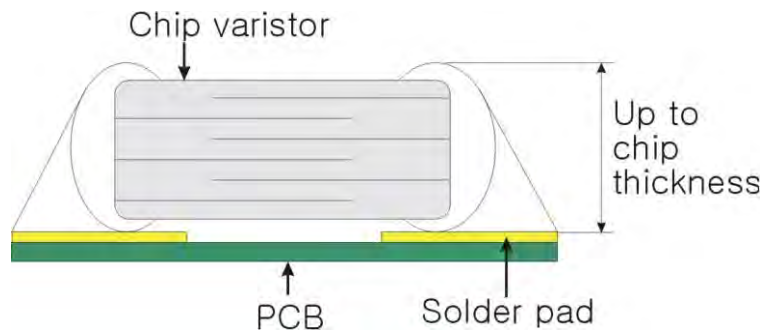

7.3 Soldering guidelines

7.3.1 Our chip varistors are designed for reflow soldering only. Do not use flow soldering

7.3.2 Use non-activated flux (Cl content 0.2% max.)

7.3.3 Follow the recommended soldering conditions to avoid varistor damage.

6 Packaging Specification

8.1 Carrier tape transparent cover tape should be heat-sealed to carry the products, and the reel should be used to reel the carrier tape.

8.2 The adhesion of the heat-sealed cover tape shall be $40 + 20 / - 15$ grams.

8.3 Both the head and the end portion of taping shall be empty for reel package and SMT auto-pickup machine. And a normal paper tape shall be connected in the head of taping for the operator handle.

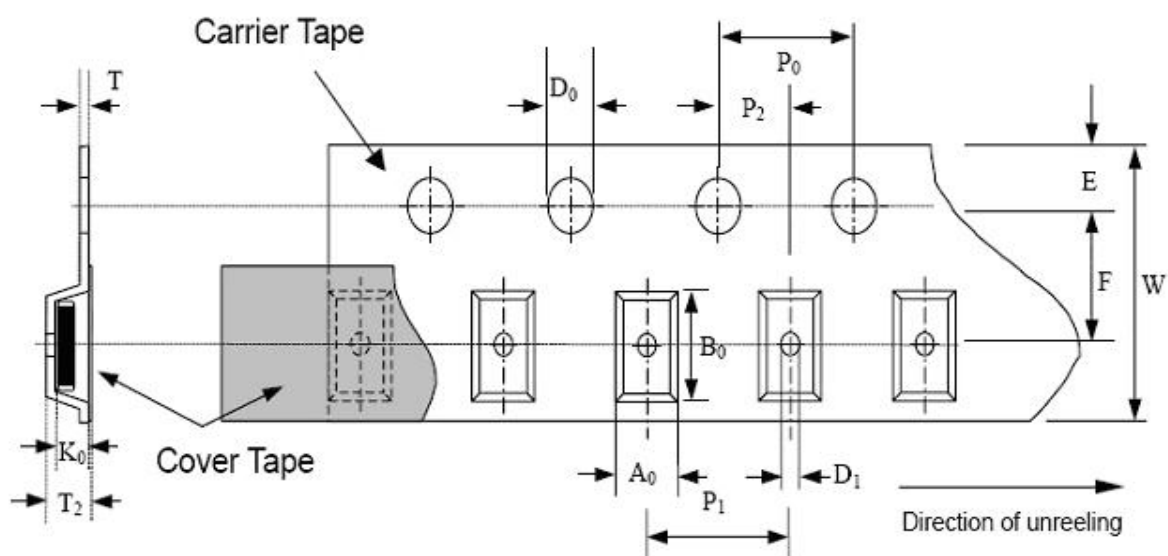

type	A ₀ ±0.10	B ₀ ±0.10	K ₀ ±0.10	T ±0.05	T ₂ ±0.05	D ₀ +0.10	D ₁ ±0.05	P ₁ ±0.10	P ₂ ±0.05	P ₀ ±0.05	W ±0.20	E ±0.10	F ±0.05
0402	1.08	1.88	1.04	0.22	0.87	1.50	1.00	4.00	2.00	4.00	8.00	1.75	3.50
0603	1.08	1.88	1.04	0.22	1.17	1.50	1.00	4.00	2.00	4.00	8.00	1.75	3.50
0805	1.42	2.30	1.04	0.22	1.26	1.50	1.00	4.00	2.00	4.00	8.00	1.75	3.50
1206	1.88	3.50	1.27	0.20	1.49	1.50	1.00	4.00	2.00	4.00	8.00	1.75	3.50
1210	2.18	3.46	1.45	0.22	1.77	1.50	1.00	4.00	2.00	4.00	8.00	1.75	3.50
1812	3.66	4.95	1.74	0.25	1.99	1.50	1.50	8.00	2.00	4.00	12.00	1.75	5.50
2220	5.10	5.97	2.80	0.25	3.05	1.50	1.50	8.00	2.00	4.00	12.00	1.75	5.50
3220	5.50	8.50	2.80	0.30	3.50	1.50	1.50	8.00	2.00	4.00	16.00	1.75	7.50

7. reel dimension

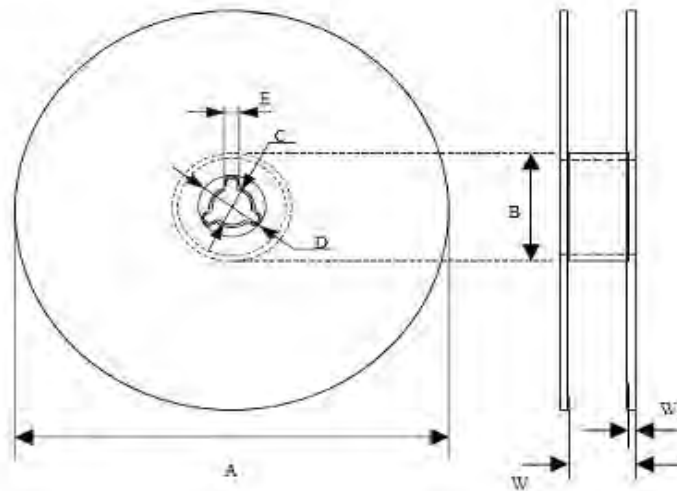

type	A	B	C	D	E	W	W ₁
0402-1210	178.0±1.0	60.0±0.5	13.0±0.2	21.0±0.2	2.0±0.5	9.0±0.50	1.5±0.15
1812-3220	178.0±1.0	60.0±0.5	13.5±0.1	21.0±0.2	2.0±0.5	13.6±0.2	1.5±0.15

type	0402	0603	0805	1206	1210	1812	2220	3220
quantity	paper	10000	4000	4000	-	-	-	-
	plastic	-	-	-	3000	3000	2000/3000	1000
							1000	500/1000
								1000