

Features

- Ultra low leakage: nA level
- Operating voltage: 12V
- Low clamping voltage
- Complies with following standards:
 - IEC 61000-4-2 (ESD) immunity test
 - Air discharge: $\pm 30\text{kV}$
 - Contact discharge: $\pm 30\text{kV}$
 - IEC61000-4-4 (EFT) 80A (5/50ns)
 - IEC61000-4-5 (Lightning) 64A (8/20 μs)
- RoHS Compliant

Dimensions SOD-323



Pin Configuration

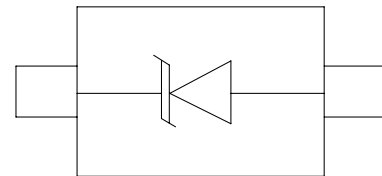

Applications

- Mobile Phones and Accessories
- Battery Protection
- USB VBus
- Power Line Protection
- Hand Held Portable Applications

Mechanical Characteristics

- Package: SOD-323
- Lead Finish: Lead Free
- UL Flammability Classification Rating 94V-0
- Quantity Per Reel: 3,000 pcs
- Reel Size: 7 inch

Absolute Maximum Ratings (T_{amb}=25°C unless otherwise specified)

| Parameter | Symbol | Value | Unit |
|--|------------------|-------------|------|
| Peak Pulse Power (8/20 μs) | P _{pp} | 1600 | W |
| ESD per IEC 61000-4-2 (Air) | V _{ESD} | ± 30 | Kv |
| ESD per IEC 61000-4-2 (Contact) | | ± 30 | |
| Operating Temperature Range | T _J | -55 to +125 | °C |
| Storage Temperature Range | T _{STJ} | -55 to +150 | °C |

Electrical Characteristics (TA=25°C unless otherwise specified)

| Part Number | Device Marking | V _{RWM} (V) | V _{BR} (V) | I _T (mA) | V _C @10A | V _C | | I _R μA (Max) | C (Pf) (Typ.) |
|-------------|----------------|----------------------|---------------------|---------------------|---------------------|----------------|------|-------------------------|---------------|
| | | | | | | (Max) | (@A) | | |
| SD1271D3W | 72D | 12 | 12.6 | 1 | 18 | 25 | 64 | 0.1 | 550 |

Characteristic Curves

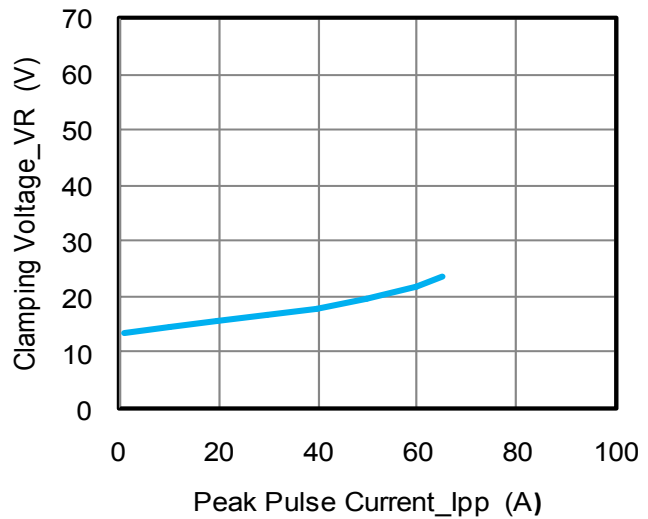
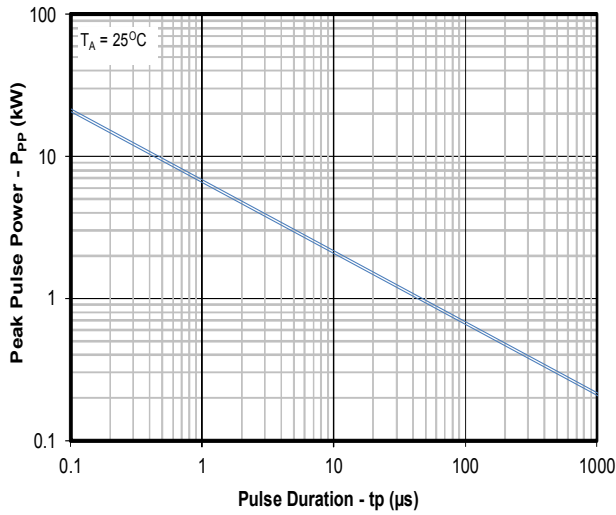

Junction Capacitance vs. Reverse Voltage

Clamping Voltage vs. Peak Pulse Current

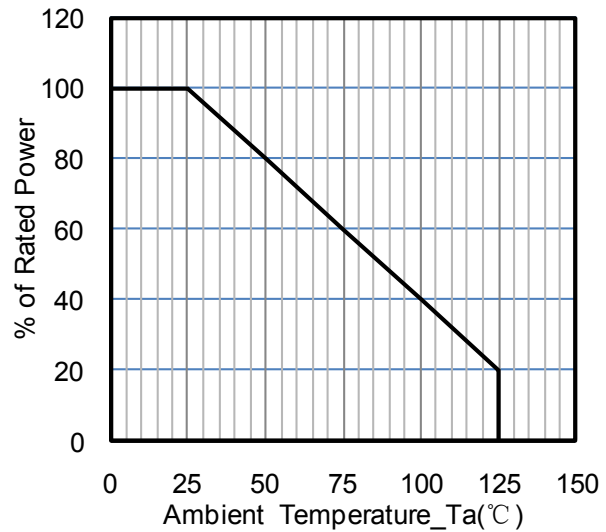
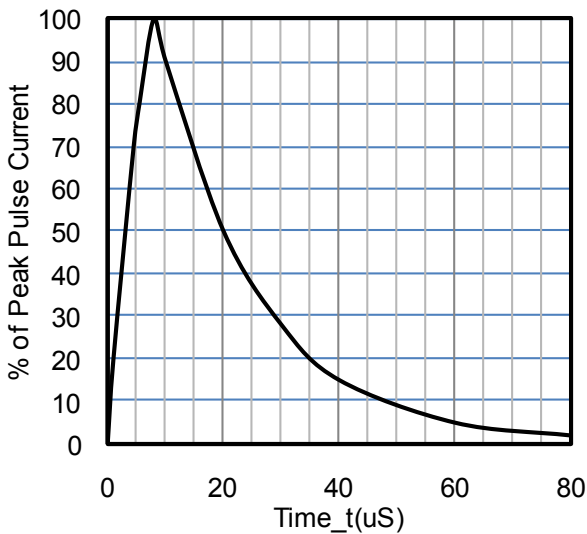

8 X 20uS Pulse Waveform

Power Derating Curve

SOD-323 Package Outline & Dimensions

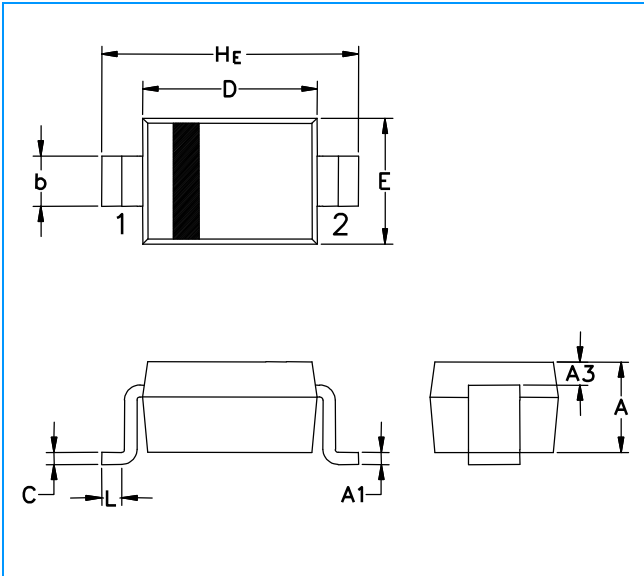

| Symbol | Millimeters | | | Inches | | |
|----------------------|-------------|------|-------|-----------|-------|-------|
| | Min. | Nom. | Max. | Min. | Nom. | Max. |
| A | 0.80 | 0.90 | 1.00 | 0.031 | 0.035 | 0.040 |
| A1 | 0.00 | 0.05 | 0.10 | 0.000 | 0.002 | 0.004 |
| A3 | 0.15 REF | | | 0.006 REF | | |
| b | 0.25 | 0.32 | 0.40 | 0.010 | 0.012 | 0.016 |
| C | 0.089 | 0.12 | 0.177 | 0.003 | 0.005 | 0.007 |
| D | 1.60 | 1.70 | 1.80 | 0.062 | 0.066 | 0.070 |
| E | 1.15 | 1.25 | 1.35 | 0.045 | 0.049 | 0.053 |
| L | 0.08 | | | 0.003 | | |
| H_E | 2.30 | 2.50 | 2.70 | 0.090 | 0.098 | 0.105 |

Soldering Footprint

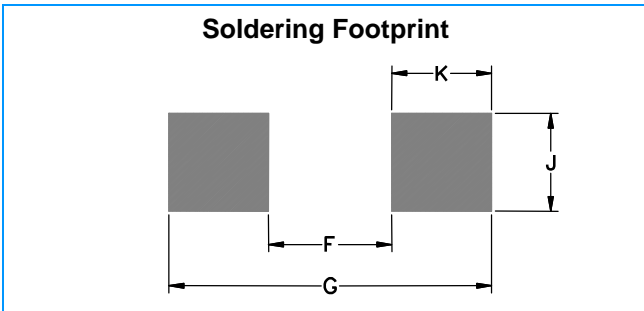

| Symbol | Millimeters | Inches |
|----------|-------------|--------|
| F | 1.60 | 0.063 |
| G | 2.85 | 0.112 |
| J | 0.83 | 0.033 |
| K | 0.63 | 0.025 |