

### Description

The LM5D150N03 uses advanced trench technology to provide excellent  $R_{DS(ON)}$ , low gate charge and operation with gate voltages as low as 4.5V. This device is suitable for use as a Battery protection or in other Switching application.

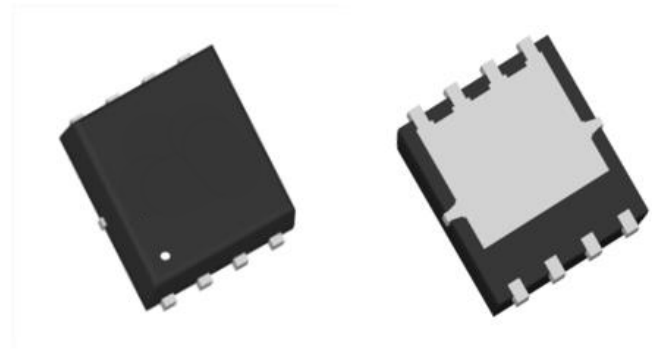
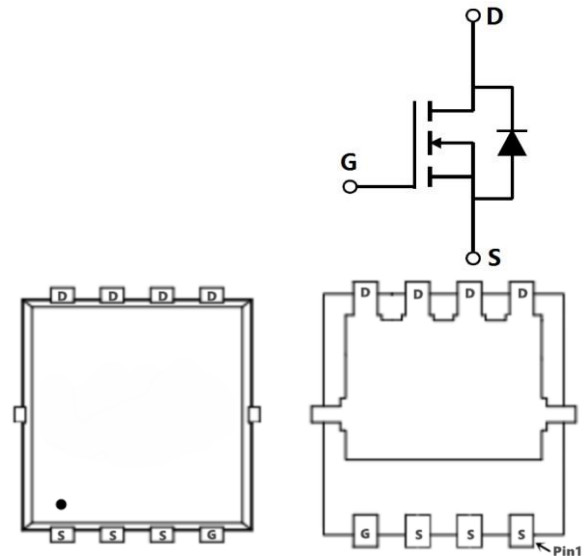
### General Features

$V_{DS} = 30V$   $I_D = 150A$

$R_{DS(ON)} < 2m\Omega$  @  $V_{GS}=10V$  (Typ.1.4 m $\Omega$ )

### Application

- Battery protection
- Load switch
- Uninterruptible power supply



### Package Marking and Ordering Information

Device	Device Marking	Device Package	Reel Size	Tape width	Quantity
LM5D150N03	AP150N03NF	DFN5X6-8	-	-	5000 units

### Absolute Maximum Ratings ( $T_c=25^\circ\text{C}$ unless otherwise noted)

Symbol	Parameter	Rating	Units
$V_{DS}$	Drain-Source Voltage	30	V
$V_{GS}$	Gate-Source Voltage	$\pm 20$	V
$I_D @ T_c=25^\circ\text{C}$	Continuous Drain Current, $V_{GS} @ 10V^{1,6}$	150	A
$I_D @ T_c=100^\circ\text{C}$	Continuous Drain Current, $V_{GS} @ 10V^{1,6}$	78	A
IDM	Pulsed Drain Current <sup>2</sup>	500	A
EAS	Single Pulse Avalanche Energy <sup>3</sup>	240	mJ
IAS	Avalanche Current	55	A
$P_D @ T_c=25^\circ\text{C}$	Total Power Dissipation <sup>4</sup>	48	W
$P_D @ T_A=25^\circ\text{C}$	Total Power Dissipation <sup>4</sup>	2.6	W
TSTG	Storage Temperature Range	-55 to 175	$^\circ\text{C}$
$T_J$	Operating Junction Temperature Range	-55 to 175	$^\circ\text{C}$
$R_{\theta JA}$	Thermal Resistance Junction-Ambient <sup>1</sup>	62	$^\circ\text{C/W}$
$R_{\theta JA}$	Thermal Resistance Junction-Ambient <sup>1</sup> ( $t \leq 10s$ )	25	$^\circ\text{C/W}$
$R_{\theta JC}$	Thermal Resistance Junction-Case <sup>1</sup>	2.6	$^\circ\text{C/W}$

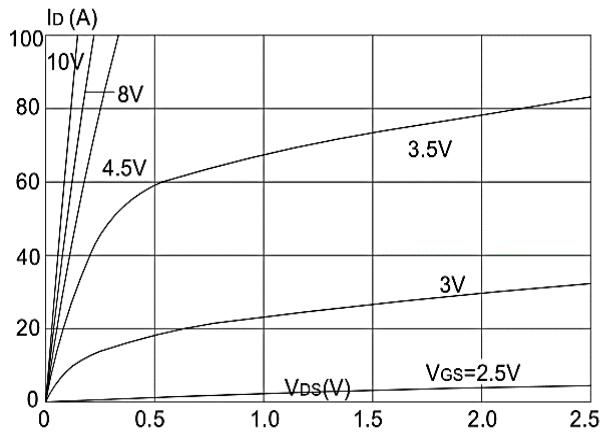
## Electrical Characteristics (T<sub>J</sub>=25°C, unless otherwise noted)

Symbol	Parameter	Conditions	Min.	Typ.	Max.	Unit
BVDSS	Drain-Source Breakdown Voltage	V <sub>GS</sub> =0V, I <sub>D</sub> =250uA	30	33	---	V
ΔBVDSS/ΔT <sub>J</sub>	BVDSS Temperature Coefficient	Reference to 25°C, I <sub>D</sub> =1mA	---	0.0213	---	V/°C
RDS(ON)	Static Drain-Source On-Resistance	V <sub>GS</sub> =10V, I <sub>D</sub> =30A	---	1.4	2.0	mΩ
		V <sub>GS</sub> =4.5V, I <sub>D</sub> =20A	---	2.3	3.2	
VGS(th)	Gate Threshold Voltage	V <sub>GS</sub> =V <sub>DS</sub> , I <sub>D</sub> =250uA	1.2	1.6	2.5	V
ΔVGS(th)	V <sub>GS(th)</sub> Temperature Coefficient		---	-5.73	---	mV/°C
IDSS	Drain-Source Leakage Current	V <sub>DS</sub> =24V, V <sub>GS</sub> =0V, T <sub>J</sub> =25°C	---	---	1	uA
		V <sub>DS</sub> =24V, V <sub>GS</sub> =0V, T <sub>J</sub> =55°C	---	---	5	
IGSS	Gate-Source Leakage Current	V <sub>GS</sub> =±20V, V <sub>DS</sub> =0V	---	---	±100	nA
R <sub>g</sub>	Gate Resistance	V <sub>DS</sub> =0V, V <sub>GS</sub> =0V, f=1MHz	---	1.4	---	Ω
Q <sub>g</sub>	Total Gate Charge (4.5V)	V <sub>DS</sub> =15V, V <sub>GS</sub> =4.5V, I <sub>D</sub> =30A	---	70	---	nC
Q <sub>gs</sub>	Gate-Source Charge		---	12	---	
Q <sub>gd</sub>	Gate-Drain Charge		---	17	---	
Td(on)	Turn-On Delay Time		---	10	---	
T <sub>r</sub>	Rise Time	V <sub>DD</sub> =15V, V <sub>GS</sub> =10V, R <sub>G</sub> =3Ω I <sub>D</sub> =30A	---	6.5	---	ns
Td(off)	Turn-Off Delay Time		---	75	---	
T <sub>f</sub>	Fall Time		---	18	---	
C <sub>iss</sub>	Input Capacitance		---	4930	---	
C <sub>oss</sub>	Output Capacitance	V <sub>DS</sub> =15V, V <sub>GS</sub> =0V, f=1MHz	---	682	---	Pf
Crss	Reverse Transfer Capacitance		---	566	---	
I <sub>s</sub>	Continuous Source Current <sup>1,5</sup>	V <sub>G</sub> =V <sub>D</sub> =0V, Force Current	---	---	120	A
ISM	Pulsed Source Current <sup>2,5</sup>		---	---	480	A
VSD	Diode Forward Voltage <sup>2</sup>	V <sub>GS</sub> =0V, I <sub>S</sub> =30A, T <sub>J</sub> =25°C	---	---	1.2	V
Q <sub>rr</sub>	Body Diode Reverse Recovery Charge	I <sub>F</sub> =20A, di/dt=100A/μs	---	30	---	ns
trr	Body Diode Reverse Recovery Time		---	15	---	nC

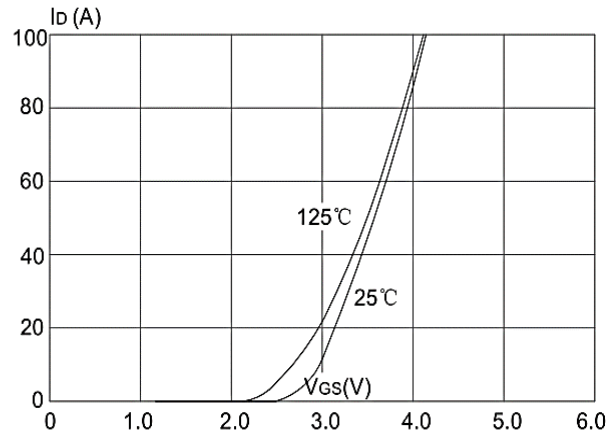
**Note :**

- 1、 The data tested by surface mounted on a 1 inch 2 FR-4 board with 2OZ copper.
- 2、 The data tested by pulsed , pulse width ≦ 300us , duty cycle ≦ 2%
- 3、 The EAS data shows Max. rating . The test condition is VDD=24V,VGS =10V,L=0.1mH,IAS =55A
- 4、 The power dissipation is limited by 150°C junction temperature
- 5、 The data is theoretically the same as ID and IDM , in real applications , should be limited by total power dissipation

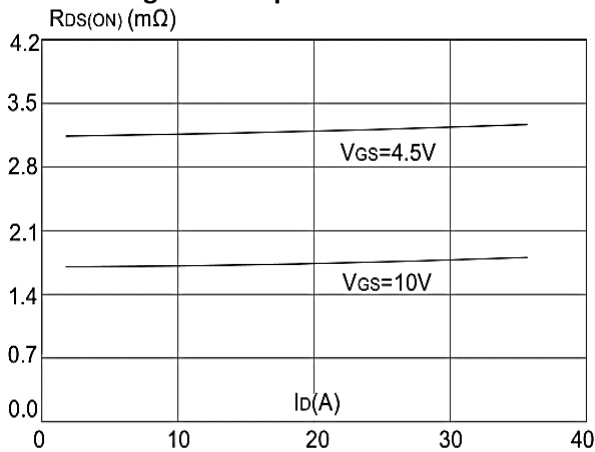
## Typical Electrical and Thermal Characteristics



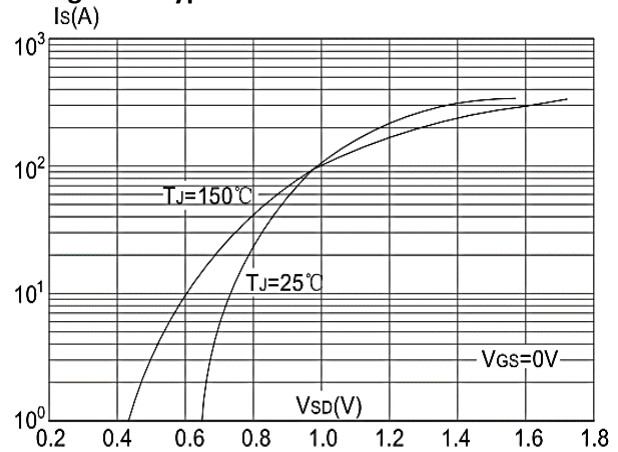
**Figure 1: Output Characteristics**



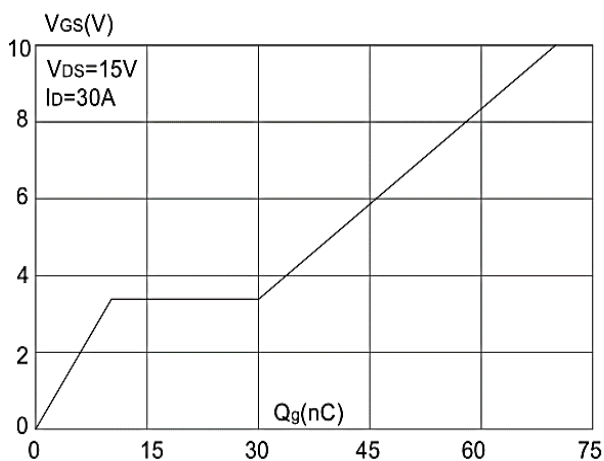
**Figure 2: Typical Transfer Characteristics**



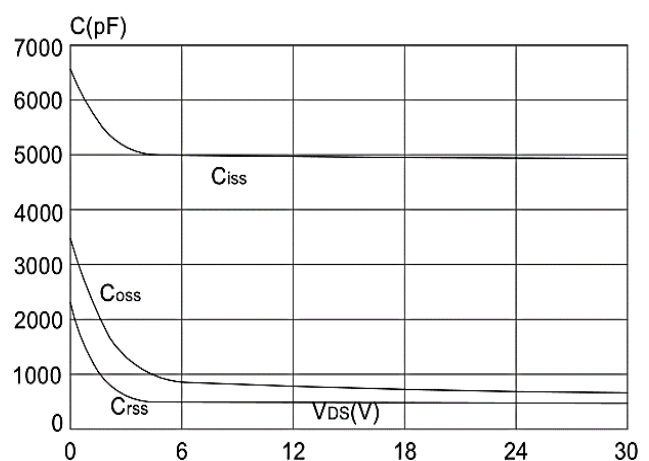
**Figure 3: On-resistance vs. Drain Current**



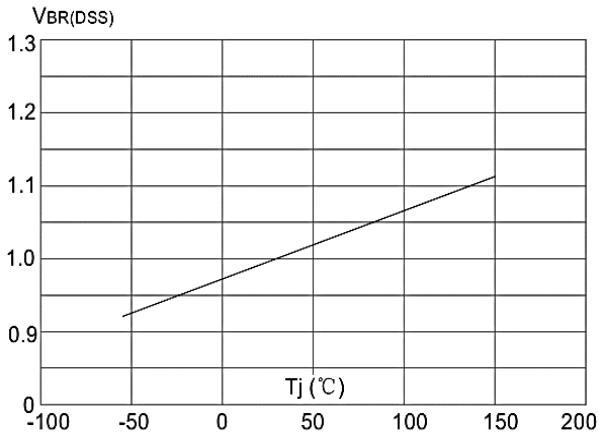
**Figure 4: Body Diode Characteristics**



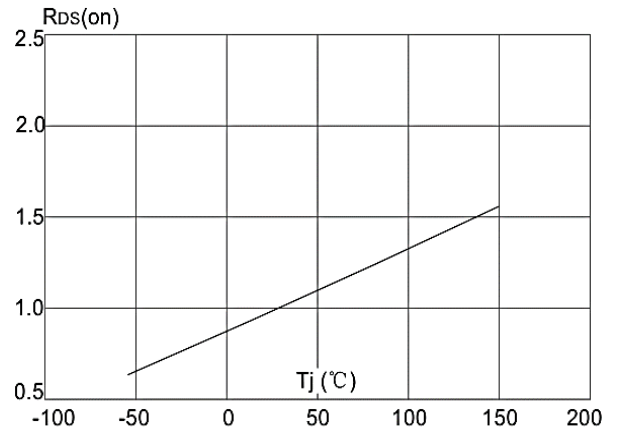
**Figure 5: Gate Charge Characteristics**



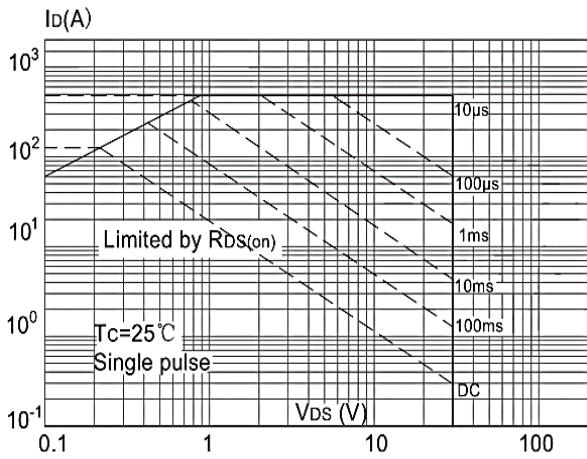
**Figure 6: Capacitance Characteristics**



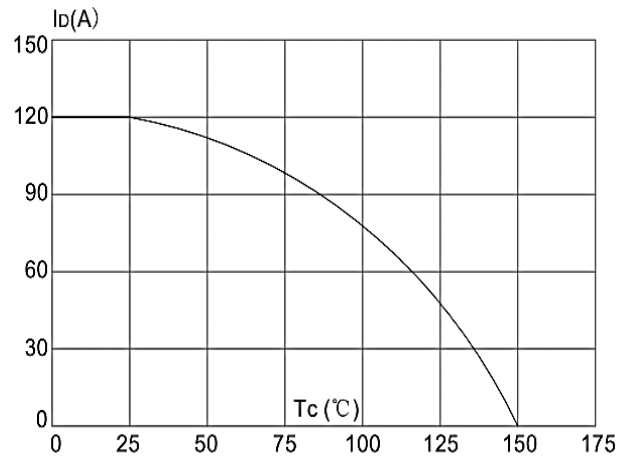
**Figure 7: Normalized Breakdown Voltage vs. Junction Temperature**



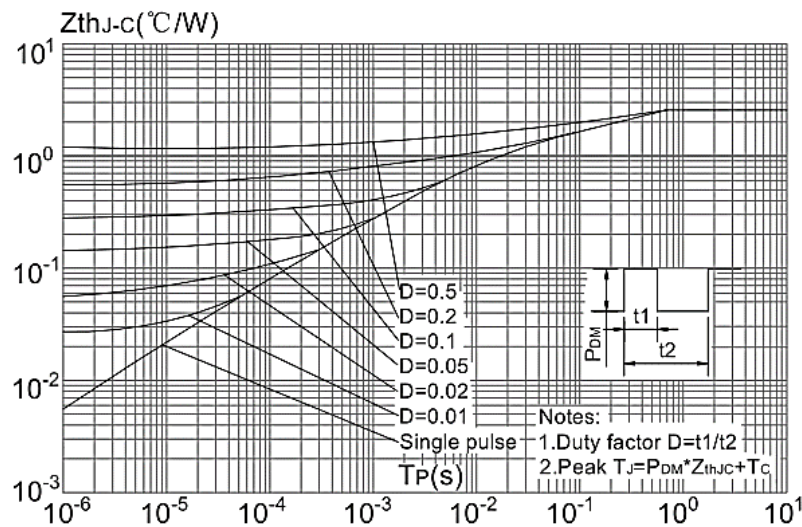
**Figure 8: Normalized on Resistance vs. Junction Temperature**



**Figure 9: Maximum Safe Operating Area vs. Case Temperature**

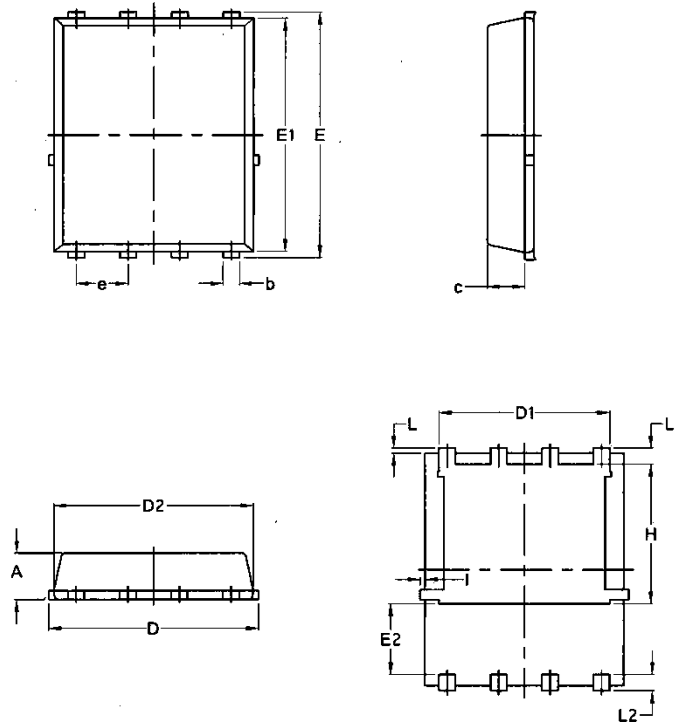


**Figure 10: Maximum Continuous Drain Current vs. Case Temperature**



**Figure 11: Maximum Effective Transient Thermal Impedance, Junction-to-Case**

## Package Mechanical Data-DFN5\*6-8-JQ Single



Symbol	Common			
	mm		Inch	
	Mim	Max	Min	Max
A	1.03	1.17	0.0406	0.0461
b	0.34	0.48	0.0134	0.0189
c	0.824	0.0970	0.0324	0.082
D	4.80	5.40	0.1890	0.2126
D1	4.11	4.31	0.1618	0.1697
D2	4.80	5.00	0.1890	0.1969
E	5.95	6.15	0.2343	0.2421
E1	5.65	5.85	0.2224	0.2303
E2	1.60	/	0.0630	/
e	1.27 BSC		0.05 BSC	
L	0.05	0.25	0.0020	0.0098
L1	0.38	0.50	0.0150	0.0197
L2	0.38	0.50	0.0150	0.0197
H	3.30	3.50	0.1299	0.1378
I	/	0.18	/	0.0070

Shanghai Leiditech Electronic Co.,Ltd  
 Email: sale1@leiditech.com  
 Tel : +86- 021 50828806  
 Fax : +86- 021 50477059