

Features

- Ultra low leakage: nA level
- Operating voltage: 5V
- Low clamping voltage
- Complies with following standards:
 - IEC 61000-4-2 (ESD) immunity test
 - Air discharge: $\pm 20\text{kV}$
 - Contact discharge: $\pm 20\text{kV}$
 - IEC61000-4-4 (EFT) 40A (5/50ns)
 - IEC61000-4-5 (Lightning) 7A (8/20 μs)
- RoHS Compliant

Dimensions SOD-523



Pin Configuration

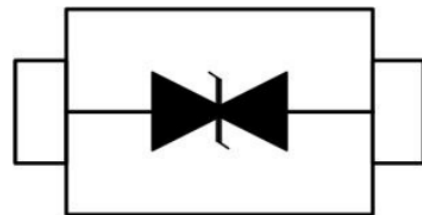

Applications

- USB 2.0 power and data line
- Set-top box and digital TV
- Digital video interface (DVI)
- Notebook Computers
- SIM Ports
- 10/100 Ethernet

Mechanical Characteristics

- Package: SOD-523
- Lead Finish: Lead Free
- UL Flammability Classification Rating 94V-0
- Quantity Per Reel: 3,000 pcs
- Reel Size: 7 inch
- Device Marking: 5C

Absolute Maximum Ratings (T_{amb}=25°C unless otherwise specified)

Parameter	Symbol	Value	Unit
Peak Pulse Power (8/20 μs)	P _{pp}	100	W
ESD per IEC 61000-4-2 (Air)	V _{ESD}	± 20	Kv
ESD per IEC 61000-4-2 (Contact)		± 20	
Operating Temperature Range	T _J	-55 to +125	°C
Storage Temperature Range	T _{STJ}	-55 to +150	°C

Electrical Characteristics (TA=25°C unless otherwise specified)

Parameter	Symbol	Test Condition	Min	Typ	Max	Unit
Reverse Working Voltage	V_{RWM}				5	V
Breakdown Voltage	V_{BR}	$I_T = 1mA$	6	7	8.5	V
Reverse Leakage Current	I_R	$V_{RWM} = 5V$			1	μA
Clamping Voltage	V_C	$I_{PP} = 1A$ (8 x 20 μs pulse)			8.5	V
Clamping Voltage	V_C	$I_{PP} = 7A$ (8 x 20 μs pulse)		11	16	V
Junction Capacitance	C_J	$V_R = 0V, f = 1MHz$		12	18	pF

Typical Performance Characteristics (T A =25°C unless otherwise Specified)

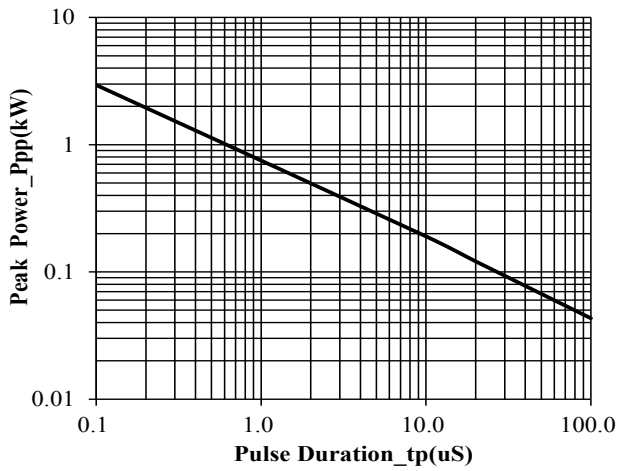

Peak Pulse Power vs. Pulse Time

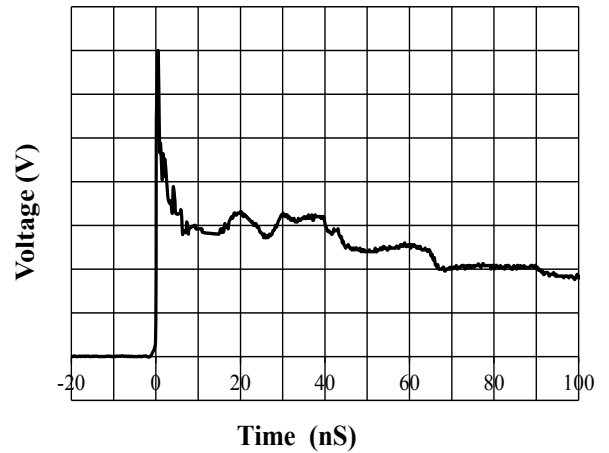

IEC61000-4-2 Pulse Waveform

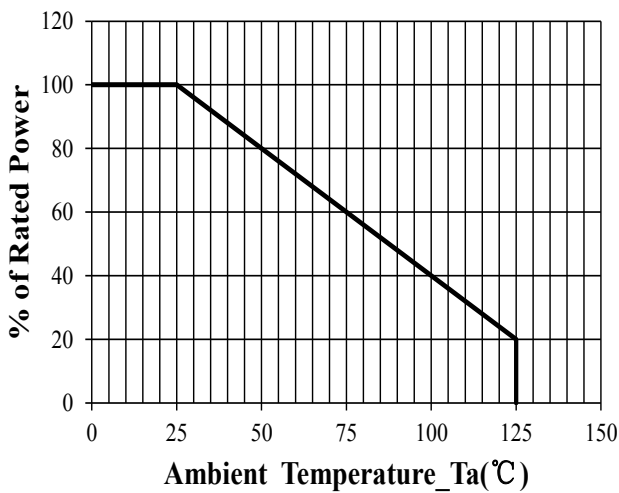

Power Derating Curve

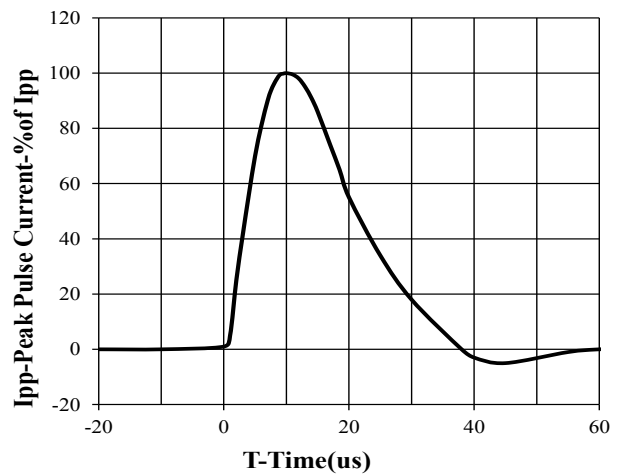

8 X 20us Pulse Waveform

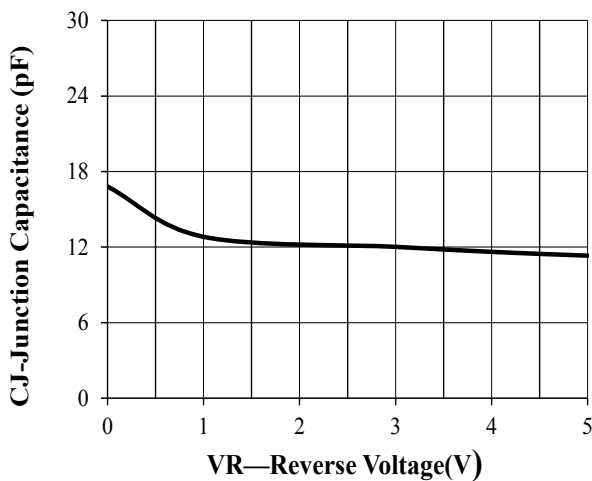

Junction Capacitance vs. Reverse Voltage

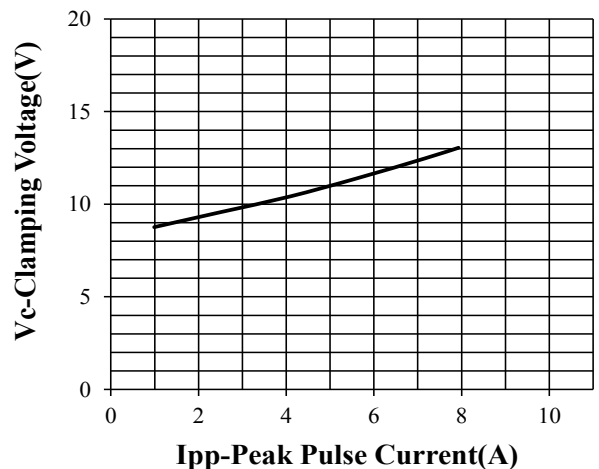

Clamping Voltage vs. Peak Pulse Current

SOD-523 Package Outline & Dimensions

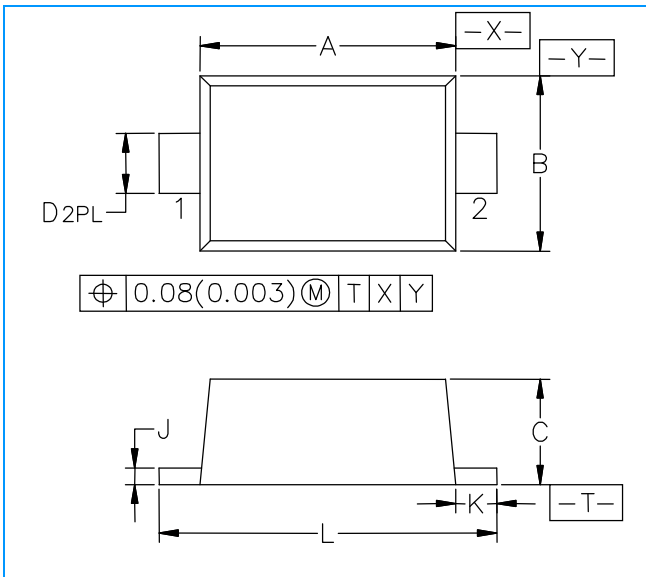

Symbol	Millimeters			Inches		
	Min.	Nom.	Max.	Min.	Nom.	Max.
A	1.10	1.20	1.30	0.043	0.047	0.051
B	0.70	0.80	0.90	0.028	0.032	0.035
C	0.50	0.60	0.70	0.020	0.024	0.028
D	0.25	0.30	0.35	0.010	0.012	0.014
J	0.07	0.14	0.20	0.0028	0.0055	0.0079
K	0.15	0.20	0.25	0.006	0.008	0.010
L	1.50	1.60	1.70	0.059	0.063	0.067

Soldering Footprint

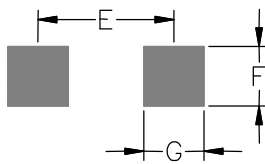

Symbol	Millimeters	Inches
E	1.40	0.0547
F	0.40	0.0157
G	0.40	0.0157