

FEATURES

- Fast Switching Speed
- Surface Mount Package Ideally Suited for Automatic Insertion
- For General Purpose Switching Applications
- High Conductance

SOD-323

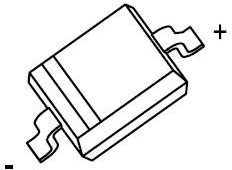

MARKING: T4



Maximum Ratings and Electrical Characteristics, Single Diode @T_a=25°C

Parameter	Symbol	Limit	Unit
Non-Repetitive Peak Reverse Voltage	V _{RM}	100	V
Peak Repetitive Peak Reverse Voltage	V _{RRM}	100	V
Working Peak Reverse Voltage	V _{RWM}		
DC Blocking Voltage	V _R		
RMS Reverse Voltage	V _{R(RMS)}	71	V
Forward Continuous Current	I _{FM}	300	mA
Average Rectified Output Current	I _O	150	mA
Non-Repetitive Peak Forward Surge Current @t=8.3ms	I _{FSM}	2.0	A
Power Dissipation	P _d	200	mW
Thermal Resistance from Junction to Ambient	R _{θJA}	625	°C/W
Junction Temperature	T _j	150	°C
Storage Temperature	T _{STG}	-55~+150	°C

ELECTRICAL CHARACTERISTICS

Electrical Ratings @Ta=25°C

Parameter	Symbol	Min	Typ	Max	Unit	Conditions
Forward voltage	V_{F1}			0.715	V	$I_F=1\text{mA}$
	V_{F2}			0.855	V	$I_F=10\text{mA}$
	V_{F3}			1.0	V	$I_F=50\text{mA}$
	V_{F4}			1.25	V	$I_F=150\text{mA}$
Reverse current	I_{R1}			1	μA	$V_R=75\text{V}$
	I_{R2}			25	nA	$V_R=20\text{V}$
Capacitance between terminals	C_T			2	pF	$V_R=0\text{V}, f=1\text{MHz}$
Reverse recovery time	t_{rr}			4	ns	$I_F=I_R=10\text{mA}$ $I_{rr}=0.1 \times I_R, R_L=100\Omega$

Typical Characteristics

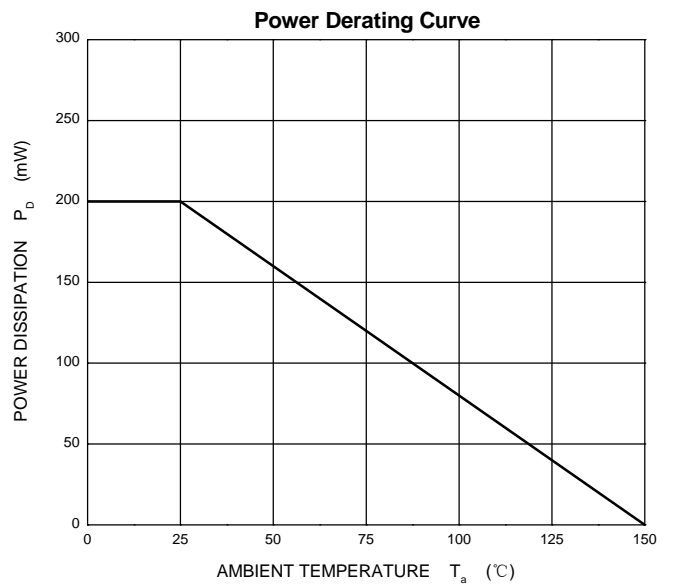
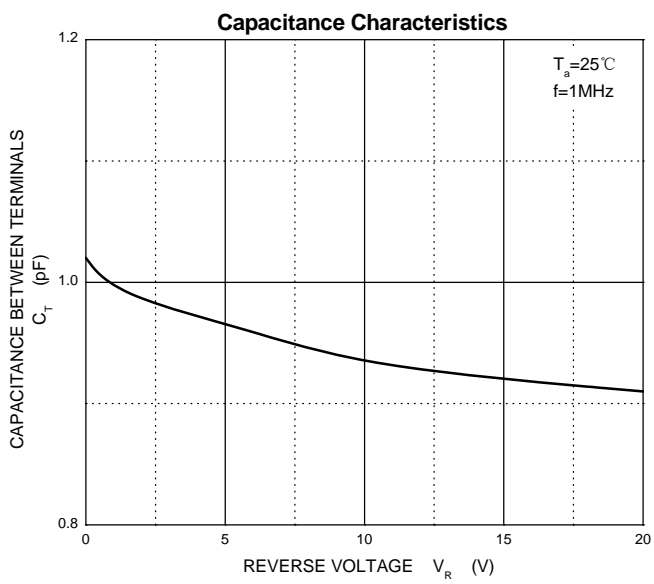
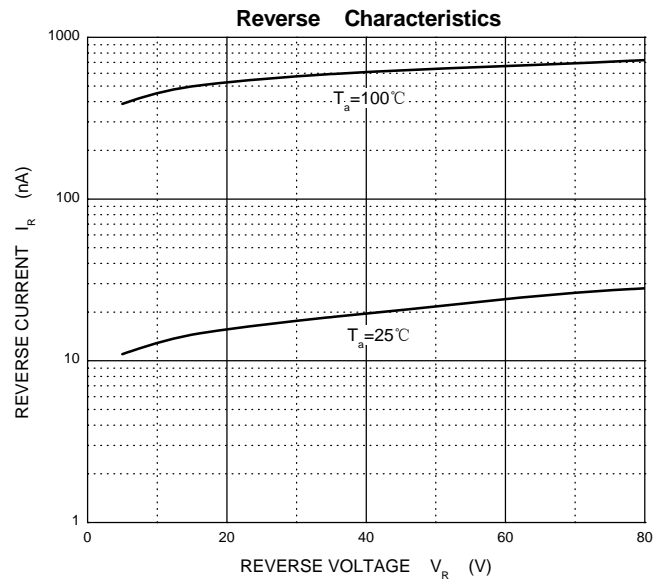
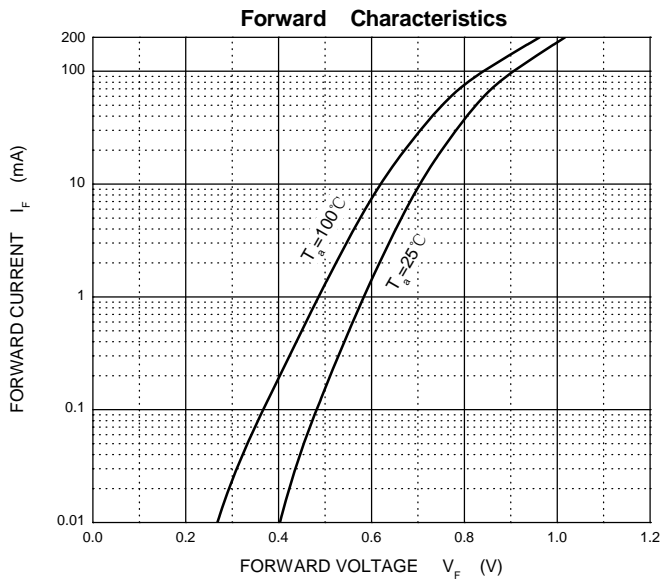

SOD-323

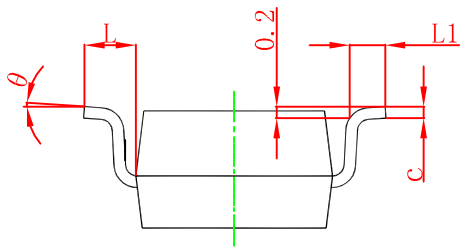
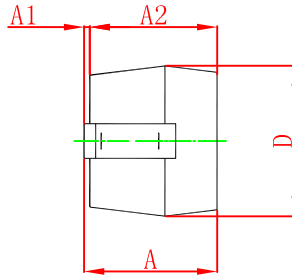
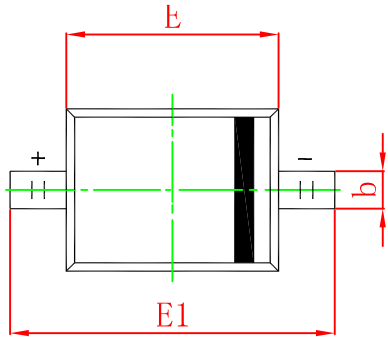

Symbol	Dimensions In Millimeters		Dimensions In Inches	
	Min.	Max.	Min.	Max.
A		1.000		0.039
A1	0.000	0.100	0.000	0.004
A2	0.800	0.900	0.031	0.035
b	0.250	0.350	0.010	0.014
c	0.080	0.150	0.003	0.006
D	1.200	1.400	0.047	0.055
E	1.600	1.800	0.063	0.071
E1	2.550	2.750	0.100	0.108
L	0.475 REF.		0.019 REF.	
L1	0.250	0.400	0.010	0.016
θ	0°	8°	0°	8°

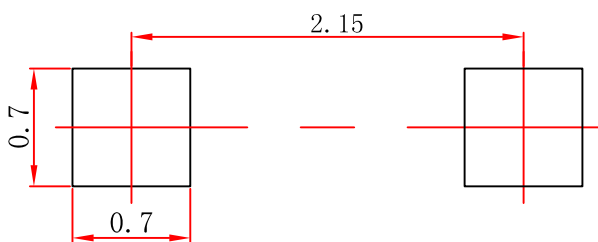

Note:

1. Controlling dimension: in millimeters.
2. General tolerance: $\pm 0.05\text{mm}$.
3. The pad layout is for reference purposes only.