

### Features

- Ultra low leakage: nA level
- Operating voltage: 5V
- Low clamping voltage
- Complies with following standards:
  - IEC 61000-4-2 (ESD) immunity test
    - Air discharge:  $\pm 20\text{kV}$
    - Contact discharge:  $\pm 20\text{kV}$
  - IEC61000-4-4 (EFT) 40A (5/50ns)
  - IEC61000-4-5 (Lightning) 3A (8/20 $\mu\text{s}$ )
- RoHS Compliant

### Dimensions DFN1006

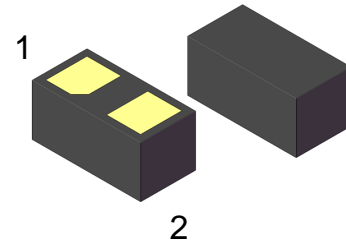

### Pin Configuration

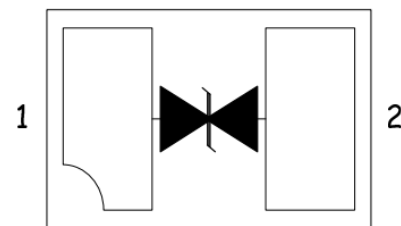

### Applications

- Smart phones
- Display Ports
- MDDI Ports
- USB Ports
- Digital Video Interface (DVI)
- PCI Express and Serial SATA Ports

### Mechanical Characteristics

- Package: DFN1006
- Lead Finish: Lead Free
- UL Flammability Classification Rating 94V-0
- Quantity Per Reel: 10,000pcs
- Reel Size: 7 inch
- Device Marking: BV

### Absolute Maximum Ratings (T<sub>amb</sub>=25°C unless otherwise specified)

Parameter	Symbol	Value	Unit
Peak Pulse Power (8/20 $\mu\text{s}$ )	P <sub>pk</sub>	45	W
ESD per IEC 61000-4-2 (Air)	V <sub>ESD</sub>	$\pm 20$	Kv
ESD per IEC 61000-4-2 (Contact)		$\pm 20$	
Operating Temperature Range	T <sub>J</sub>	-55 to +125	°C
Storage Temperature Range	T <sub>STJ</sub>	-55 to +150	°C

## Electrical Characteristics (TA=25°C unless otherwise specified)

Parameter	Symbol	Test Condition	Min	Typ	Max	Unit
Reverse Working Voltage	VRWM				5	V
Breakdown Voltage	VBR	IT = 1mA	6			V
Reverse Leakage Current	IR	VRWM = 5V			0.2	uA
Clamping Voltage	VC	IPP = 1A (8 x 20µs pulse)			11	V
Clamping Voltage	VC	IPP = 3A (8 x 20µs pulse)			15	V
Junction Capacitance	CJ	VR = 0V, f = 1MHz		0.15	0.25	pF
		VR = 0V, f = 2.5GHz		0.13		pF

## Typical Performance Characteristics (TA=25°C unless otherwise Specified)

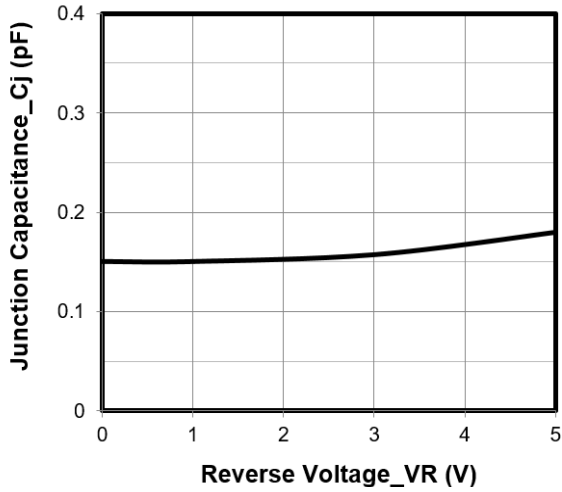

Junction Capacitance vs. Reverse Voltage

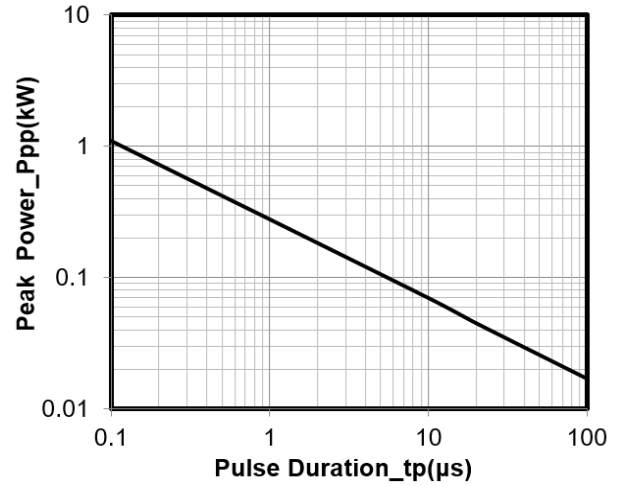

Peak Pulse Power vs. Pulse Time

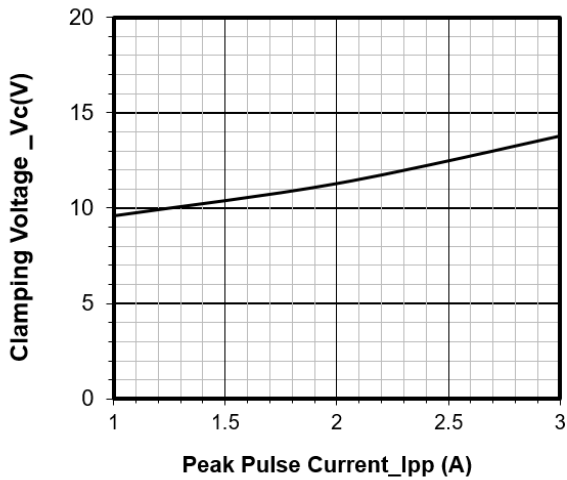

Clamping Voltage vs. Peak Pulse Current

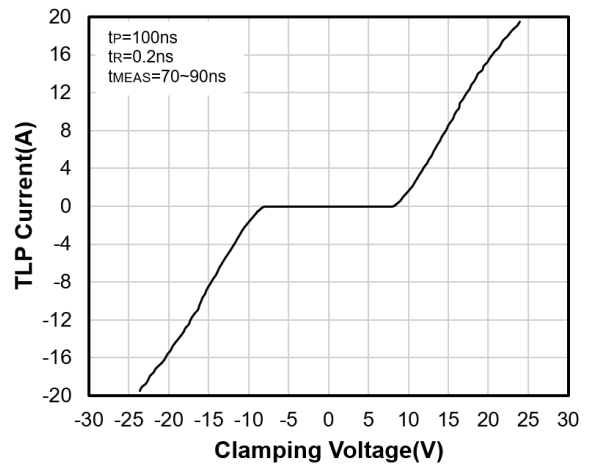

TLP Curve

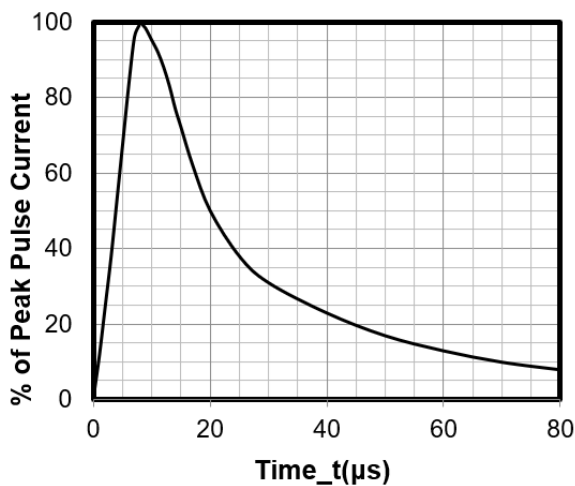

8 X 20μs Pulse Waveform

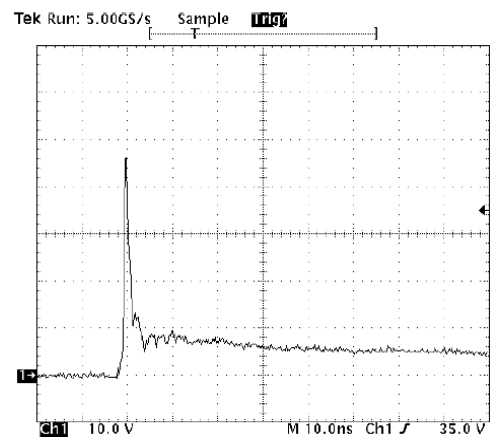

Note: Data is taken with a 10x attenuator  
ESD Clamping Voltage

## DFN1006 Package Outline Drawing

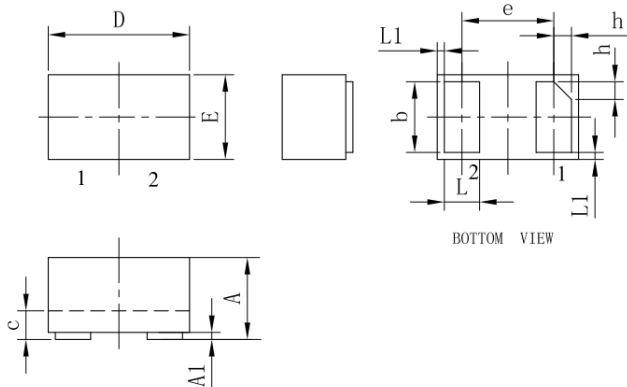

SYM	DIMENSIONS					
	MILLIMETERS			INCHES		
	MIN	NOM	MAX	MIN	NOM	MAX
A	0.45	0.50	0.55	0.018	0.020	0.022
A1	0.00	0.02	0.05	0.000	0.001	0.002
b	0.45	0.50	0.55	0.018	0.020	0.022
c	0.12	0.15	0.18	0.005	0.006	0.007
D	0.95	1.00	1.05	0.037	0.039	0.041
e	0.65 BSC			0.026 BSC		
E	0.55	0.60	0.65	0.022	0.024	0.026
L	0.20	0.25	0.30	0.008	0.010	0.012
L1	0.05REF			0.002REF		
h	0.07	0.12	0.17	0.003	0.005	0.007

## Suggested Land Pattern

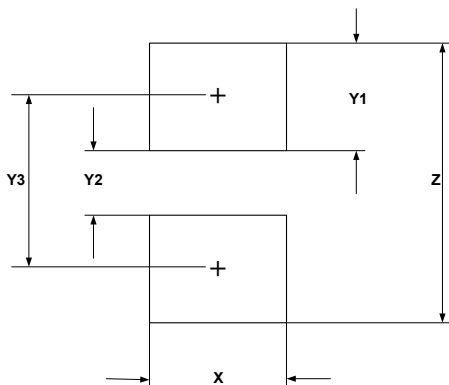

SYM	DIMENSIONS	
	MILLIMETERS	INCHES
X	0.60	0.024
Y1	0.50	0.020
Y2	0.30	0.012
Y3	0.80	0.032
Z	1.30	0.052

### NOTICE

Leiditech reserves the right to make modifications, enhancements, improvements, corrections or other changes without further notice to any product herein. Leiditech does not assume any liability arising out of the application or use of any product described herein.