

Features

- Ultra low leakage: nA level
- Operating voltage: 3.3V
- Low clamping voltage
- Complies with following standards:
 - IEC 61000-4-2 (ESD) immunity test
 - Air discharge: $\pm 30\text{kV}$
 - Contact discharge: $\pm 30\text{kV}$
 - IEC61000-4-4 (EFT) 40A (5/50ns)
 - IEC61000-4-5 (Lightning) 10A (8/20 μs)
- RoHS Compliant

Dimensions DFN1006



Pin Configuration

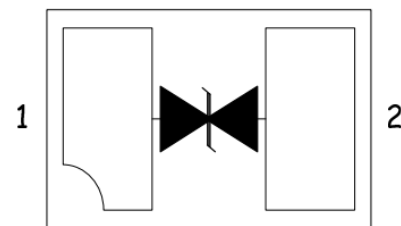

Applications

- Serial ATA
- PCI Express
- Desktops, Servers and Notebooks
- Cellular Phones
- MDDI Ports
- USB2.0/3.0/3.1 Power and Data Line Protection
- Display Ports
- Digital Visual Interfaces (DVI)
- HDMI 1.4/2.0

Mechanical Characteristics

- Package: DFN1006
- Lead Finish: Lead Free
- UL Flammability Classification Rating 94V-0
- Quantity Per Reel: 10,000 pcs
- Reel Size: 7 inch

Absolute Maximum Ratings ($T_{amb}=25^{\circ}\text{C}$ unless otherwise specified)

Parameter	Symbol	Value	Unit
Peak Pulse Power (8/20 μs)	P _{pp}	50	W
ESD per IEC 61000-4-2 (Air)	V _{ESD}	± 30	Kv
ESD per IEC 61000-4-2 (Contact)		± 30	
Operating Temperature Range	T _J	-55 to +150	$^{\circ}\text{C}$
Storage Temperature Range	T _{STJ}	-55 to +150	$^{\circ}\text{C}$

Electrical Characteristics (TA=25°C unless otherwise specified)

Part Number	Device Marking	V _{RWM} (V)	V _{BR} (V) (Min)	V _H @ I _T 50mA (V) (Min)	I _T (mA)	V _C @1A	V _C		I _R μA (Max)	C (Pf) (Typ)
							(Typ)	(@A)		
ULC0342P	AS	3.3	3.5	0.8	50	4	5	10	0.2	0.6

Portion Electronics Parameter

Symbol	Parameter
I _T	Test Current
I _{PP}	Maximum Reverse Peak Pulse Current
V _C	Clamping Voltage @I _C

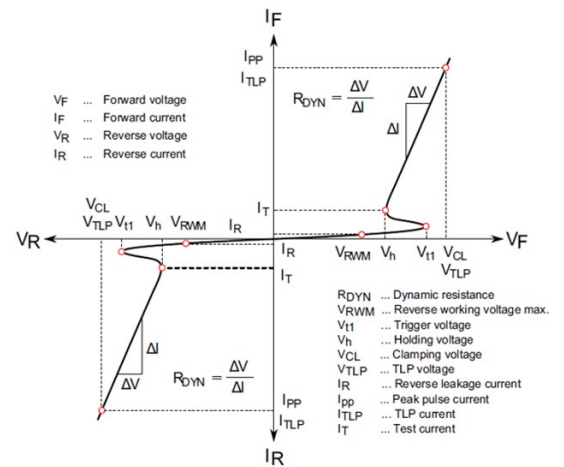

Typical Performance Characteristics ($T_A=25^\circ\text{C}$ unless otherwise Specified)

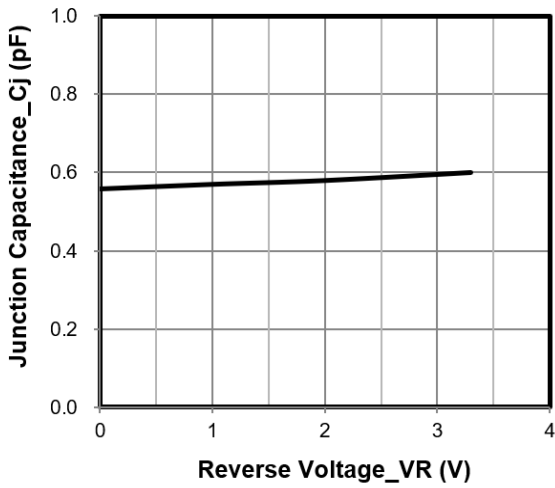

Junction Capacitance vs. Reverse Voltage

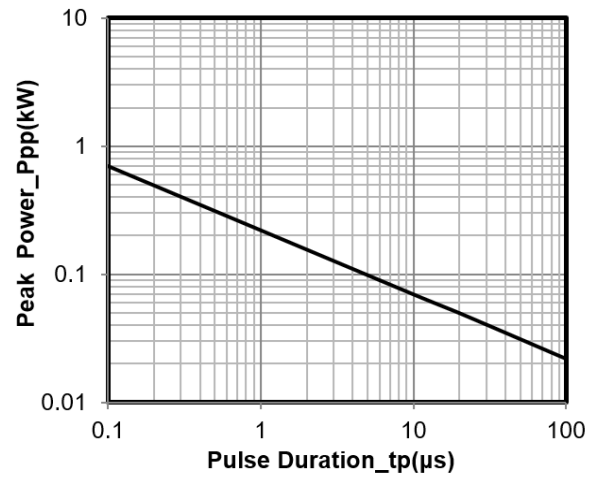

Peak Pulse Power vs. Pulse Time

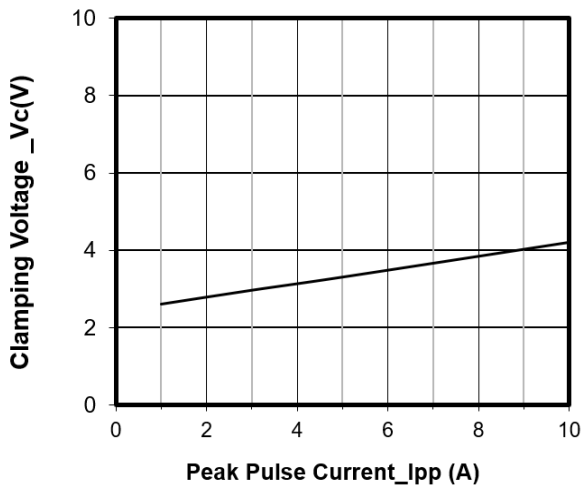

Clamping Voltage vs. Peak Pulse Current

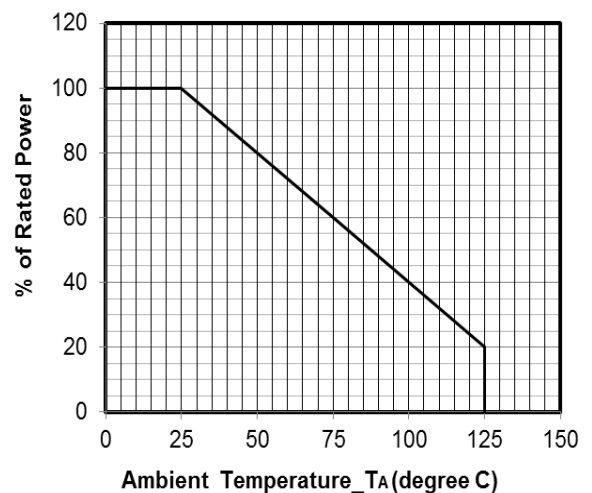

Power Derating Curve

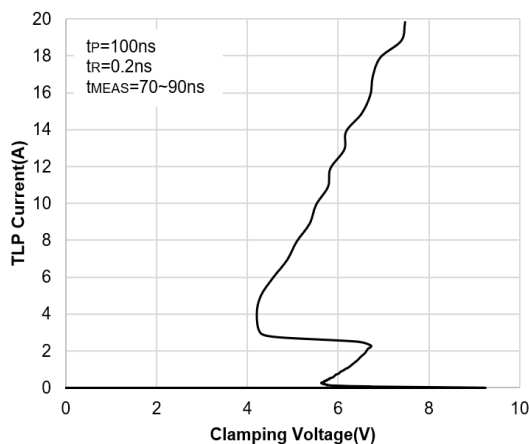

TLP I/V Curve

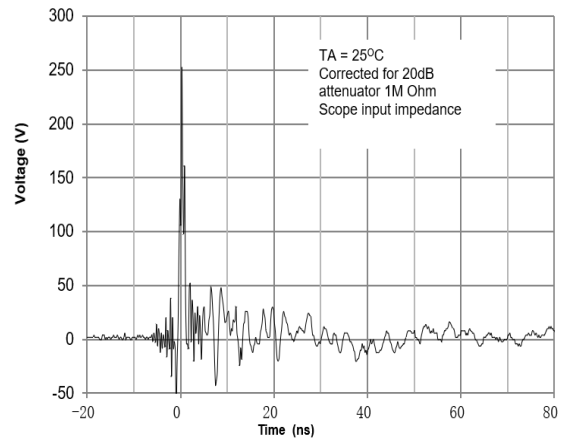

ESD Clamping Voltage
8 kV Contact per IEC61000-4-2

DFN1006 PACKAGE OUTLINE & DIMENSIONS

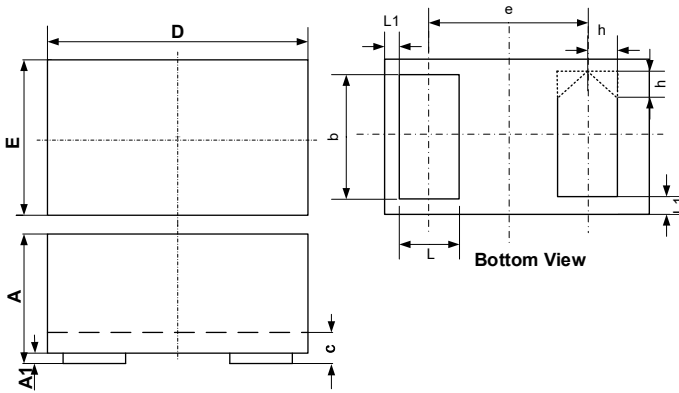

SYM	DIMENSIONS					
	MILLIMETERS			INCHES		
	MIN	NOM	MAX	MIN	NOM	MAX
A	0.45	0.50	0.55	0.018	0.020	0.022
A1	0.00	0.02	0.05	0.000	0.001	0.002
b	0.45	0.50	0.55	0.018	0.020	0.022
c	0.12	0.15	0.18	0.005	0.006	0.007
D	0.95	1.00	1.05	0.037	0.039	0.041
e	0.65 BSC			0.026 BSC		
E	0.55	0.60	0.65	0.022	0.024	0.026
L	0.20	0.25	0.30	0.008	0.010	0.012
L1	0.05REF			0.002REF		
h	0.07	0.12	0.17	0.003	0.005	0.007

Suggested Land Pattern

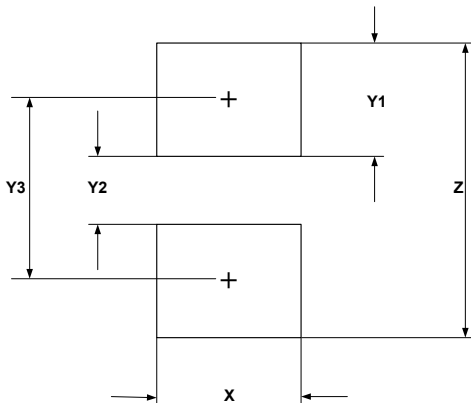

SYM	DIMENSIONS	
	MILLIMETERS	INCHES
X	0.60	0.024
Y1	0.50	0.020
Y2	0.30	0.012
Y3	0.80	0.032
Z	1.30	0.052